

# Basketball basket

Assembly instructions



### Before getting started:



The use of the structures in any way other than as described in the instructions is at the users own risk



Always place a locking pin to assemble a tube and wooden key



NEVER climb on the structures



Do not place structures in windy areas or outside on windy days



Don't hang up the structures. Do not hang anything on the structures other than what is specified in the instructions

# A. To make a basket you'll need:

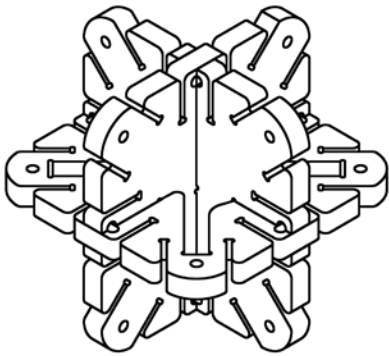

**x20**  
Assembly keys

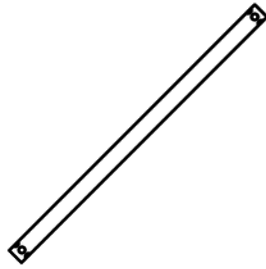

**x24**  
Short tubes

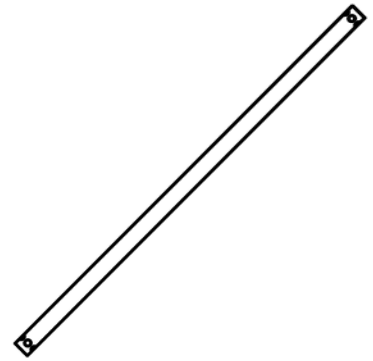

**x31**  
long tubes

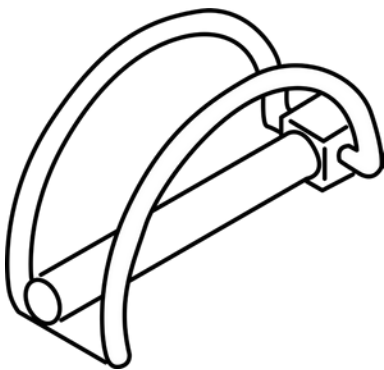

**x110**  
Locking pins

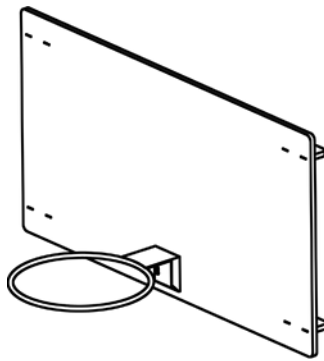

**x1**  
Basketball basket

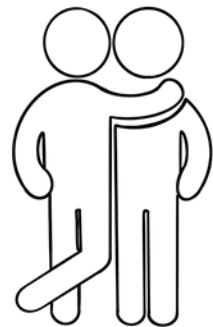

**x3**  
People minimum

# B. How to assemble a wood joint

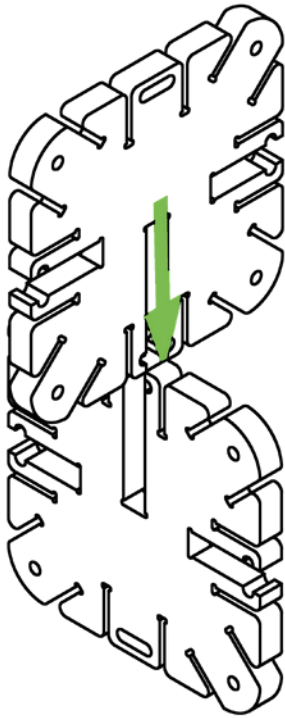

1.

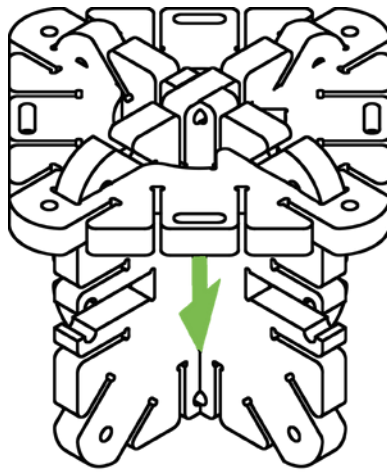

2.

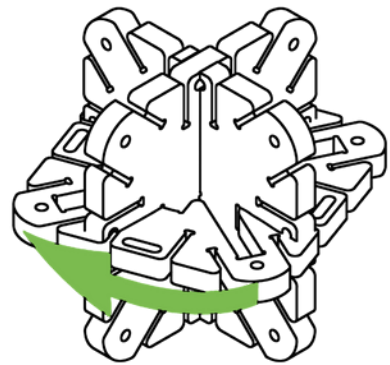

3.

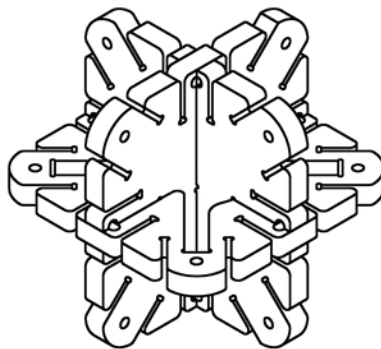

4.

# C. Let's go!

1. Assemble two initial frames. Remember to insert a pin each time!

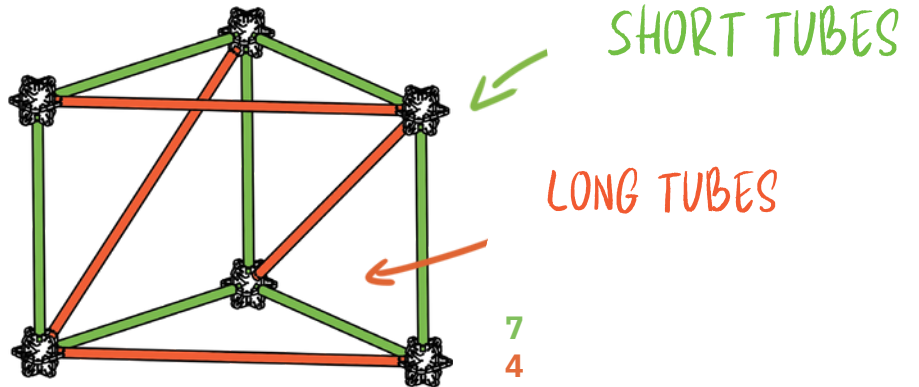

2. Finish assembling a complete cube

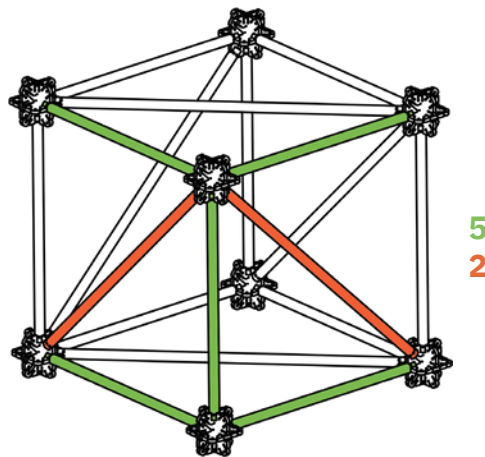

3. Expand the first cube

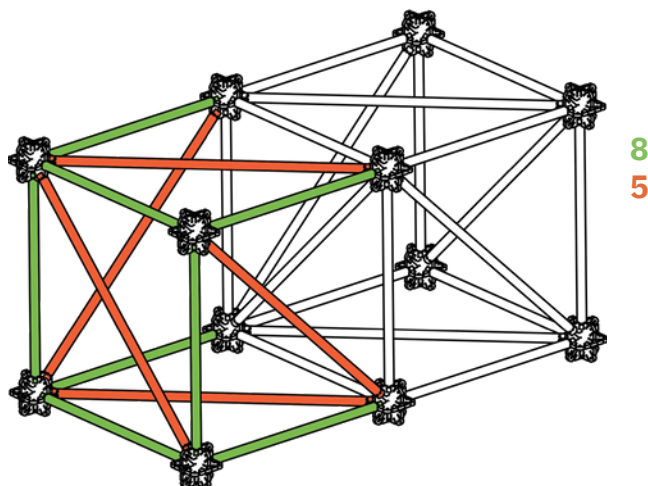

**4. Expand the structure even further.**

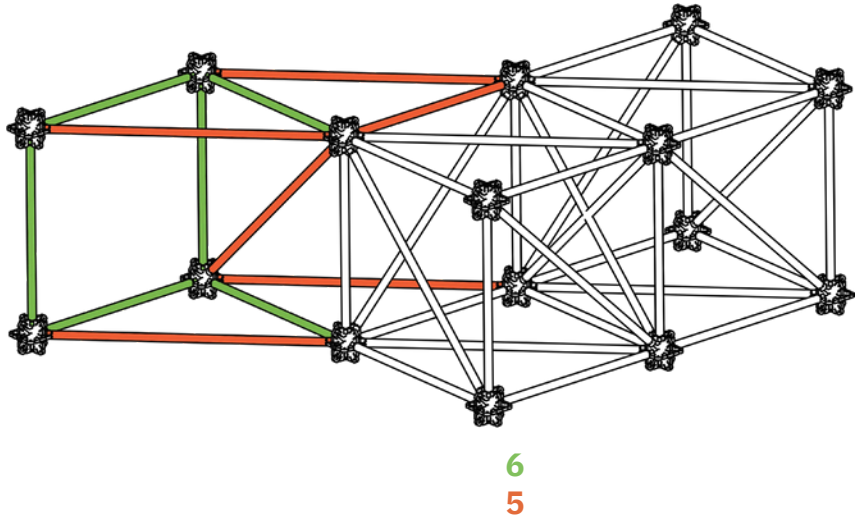

**5. Expand the structure even further.**

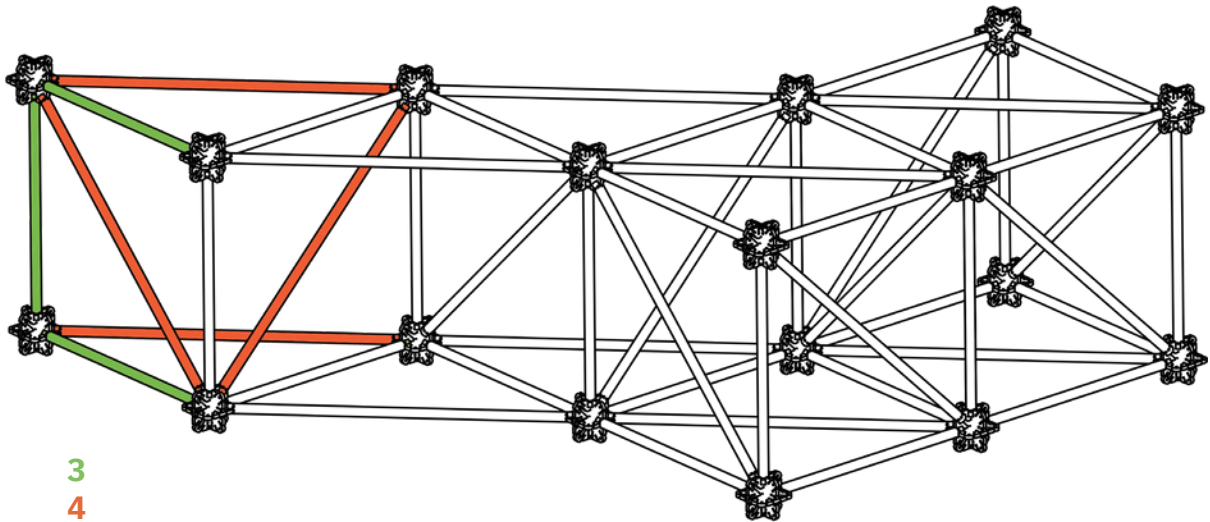

**6. You can now add the basketball tray and basket by sliding them onto the tubes.**

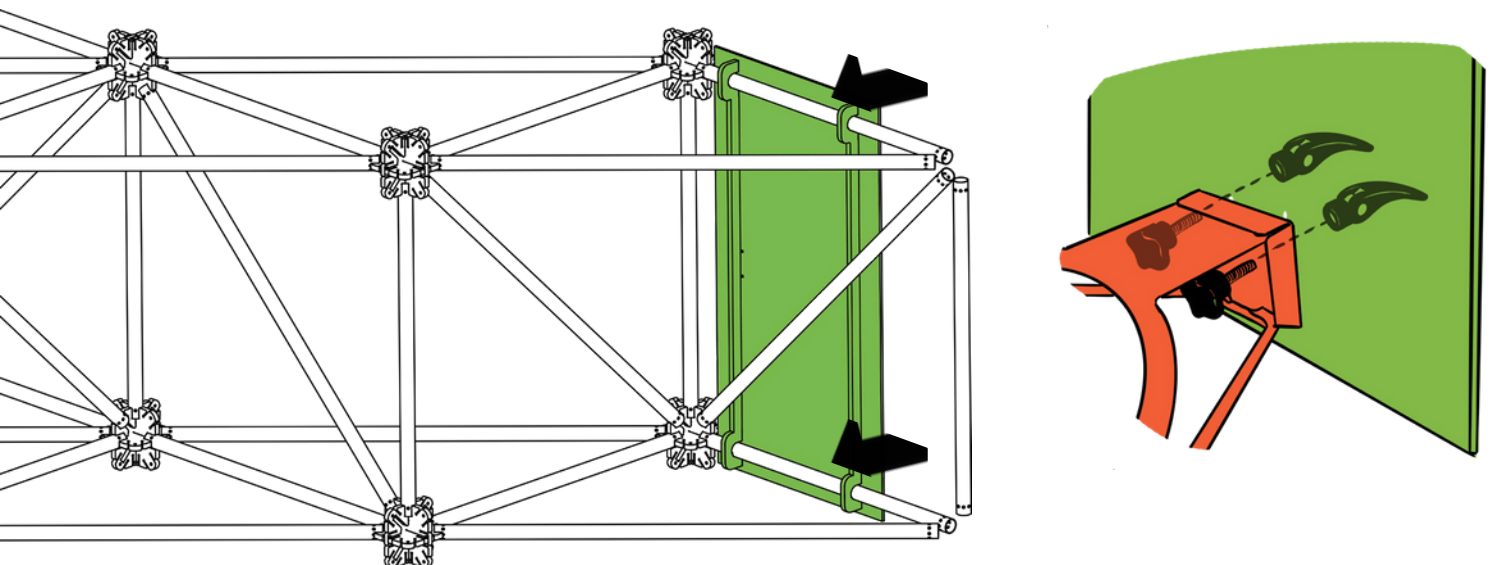

## 7. You can now straighten the frame

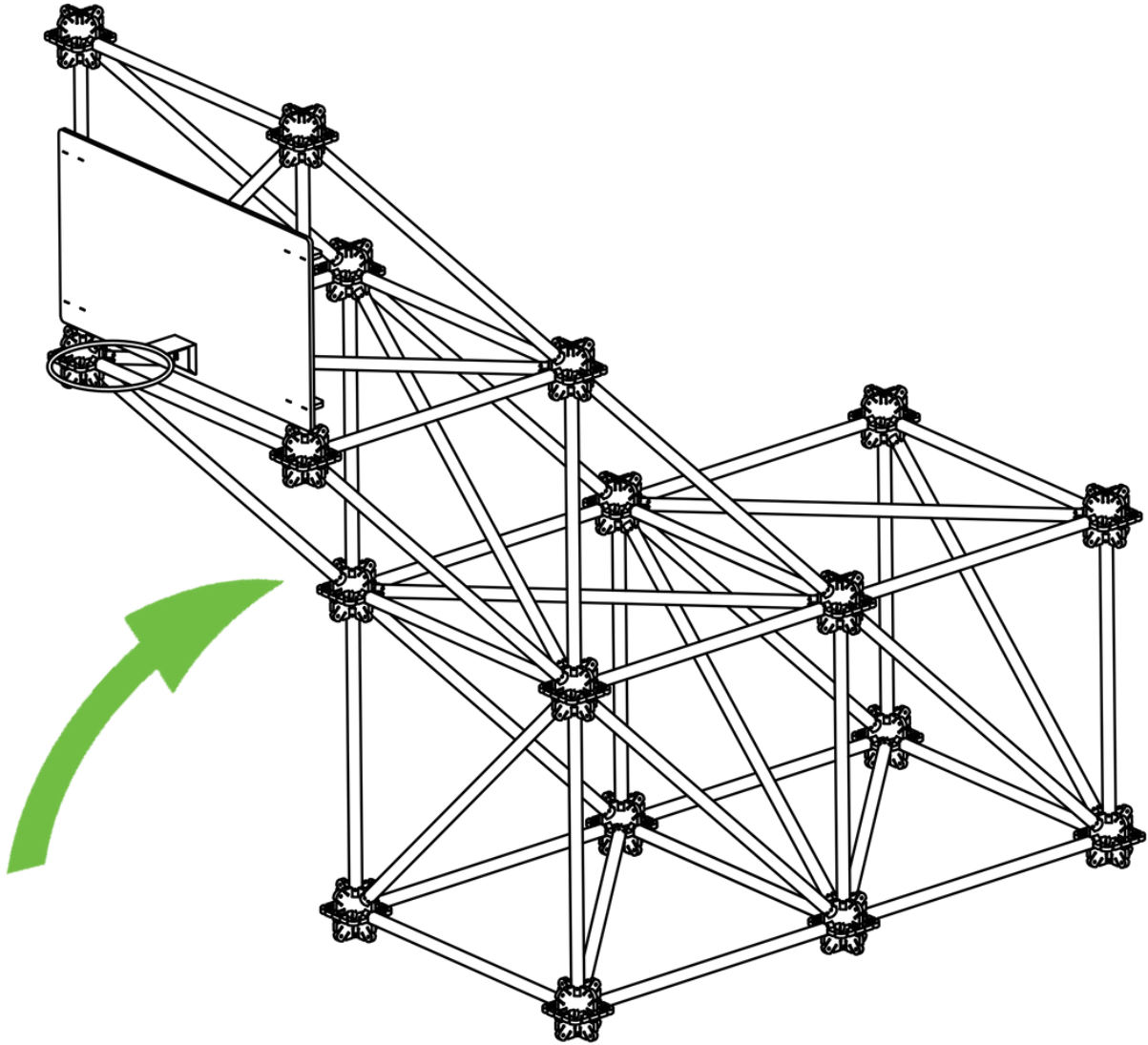

8. Strengthen the structure even more with the help of an additional base

