

# TOWER

Assembly instructions



### Before getting started:



The use of the structures in any way other than as described in the instructions is at the users own risk



Always place a locking pin to assemble a tube and wooden key



NEVER climb on the structures



Do not place structures in windy areas or outside on windy days



Don't hang up the structures. Do not hang anything on the structures other than what is specified in the instructions

# A.            To make a tower you need:

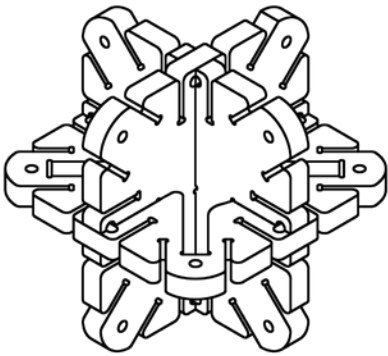

**x24**  
Assembly keys

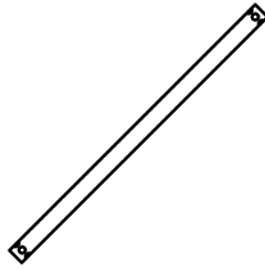

**x40**  
Short tubes

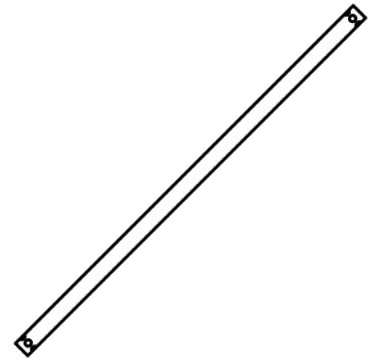

**x28**  
long tubes

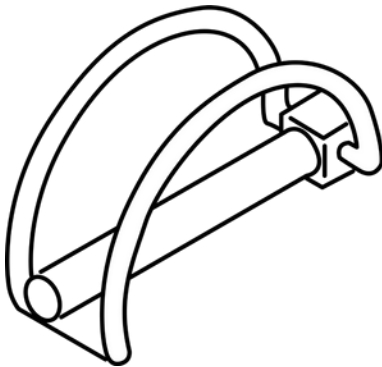

**x136**  
Locking pins

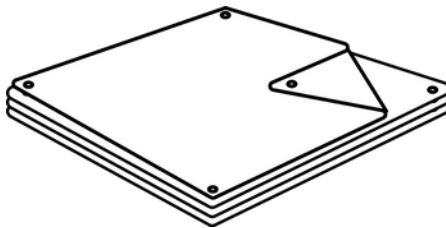

**x12**  
maximum number of tarpaulins

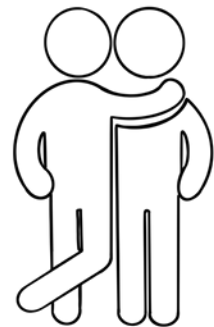

**x3**  
People minimum

# B. How to assemble a wood joint

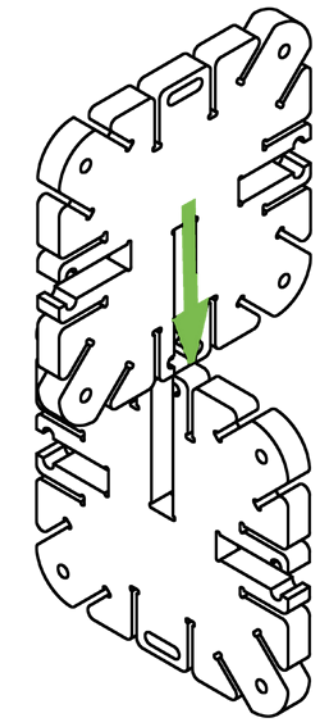

1.

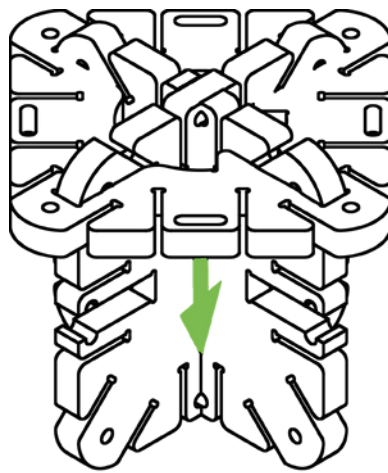

2.

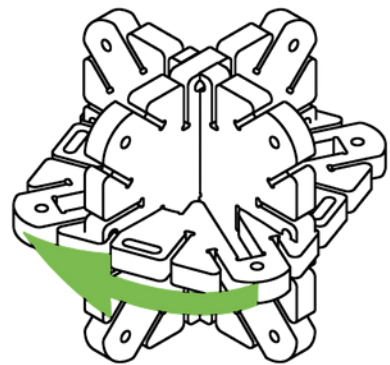

3.

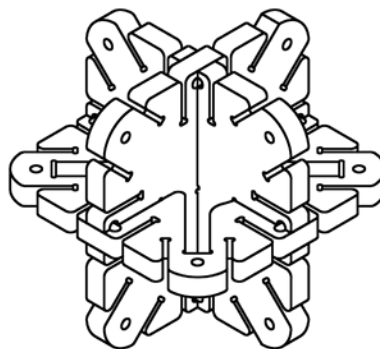

4.

# C. Let's go!

1. Assemble two initial frames. Remember to insert a pin each time!

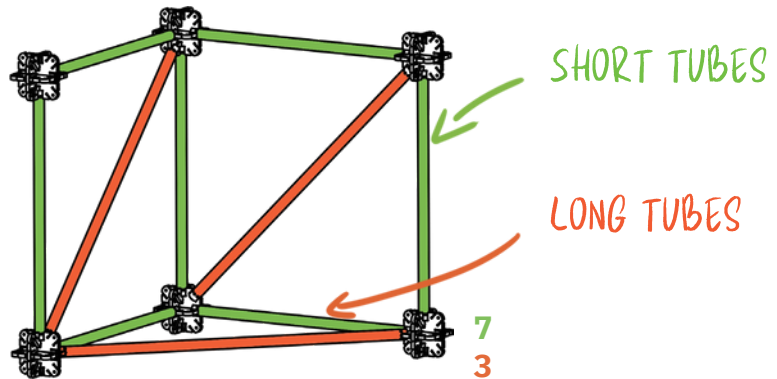

2. Complete the assembly of a complete cube.

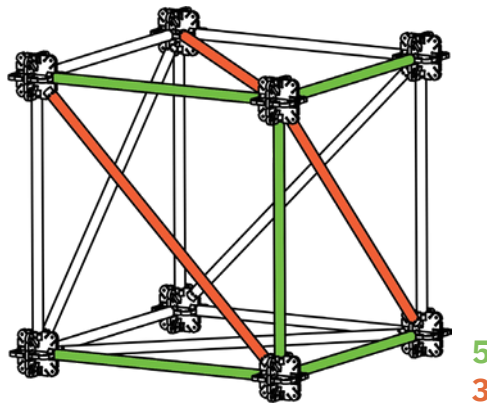

3. Expand the first cube with a second one.

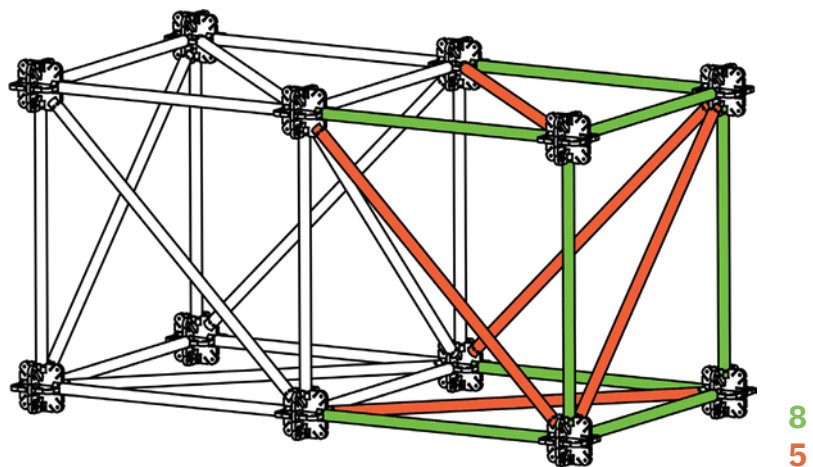

4. Expand the structure again with an additional cube.

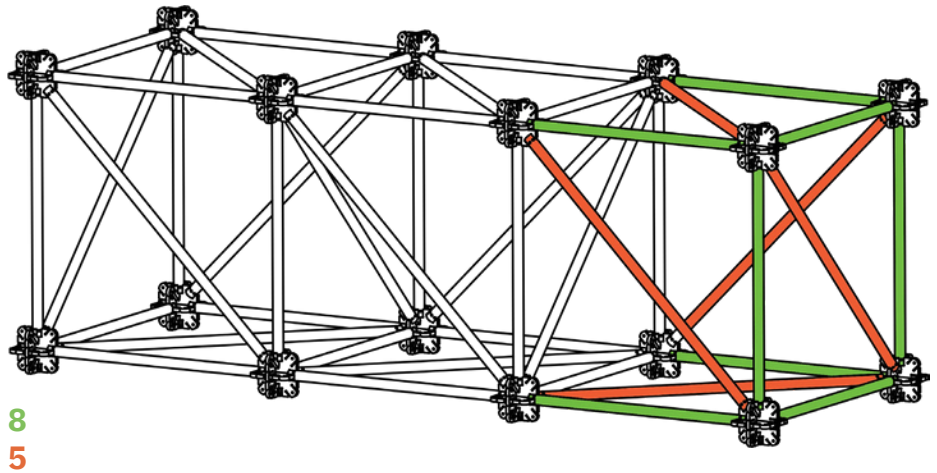

5. You can now add the taurpalins using the tensioners.

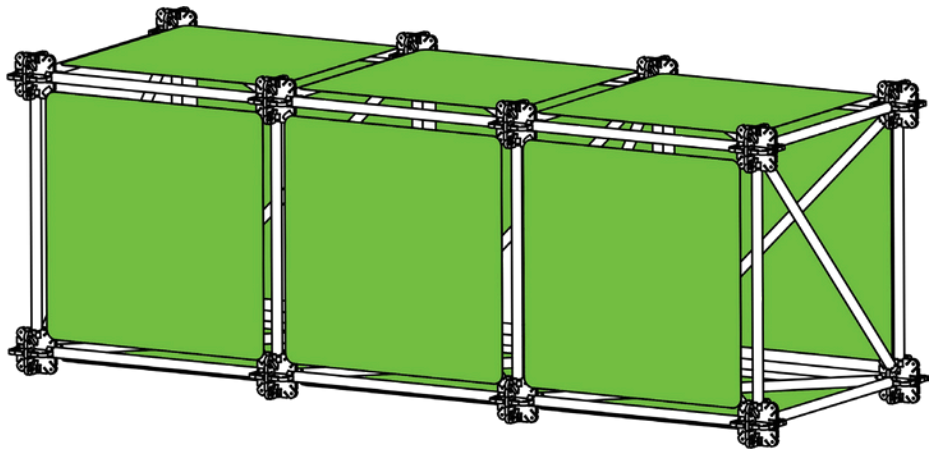

6. The time has come to put the tower straight. Don't do it alone!

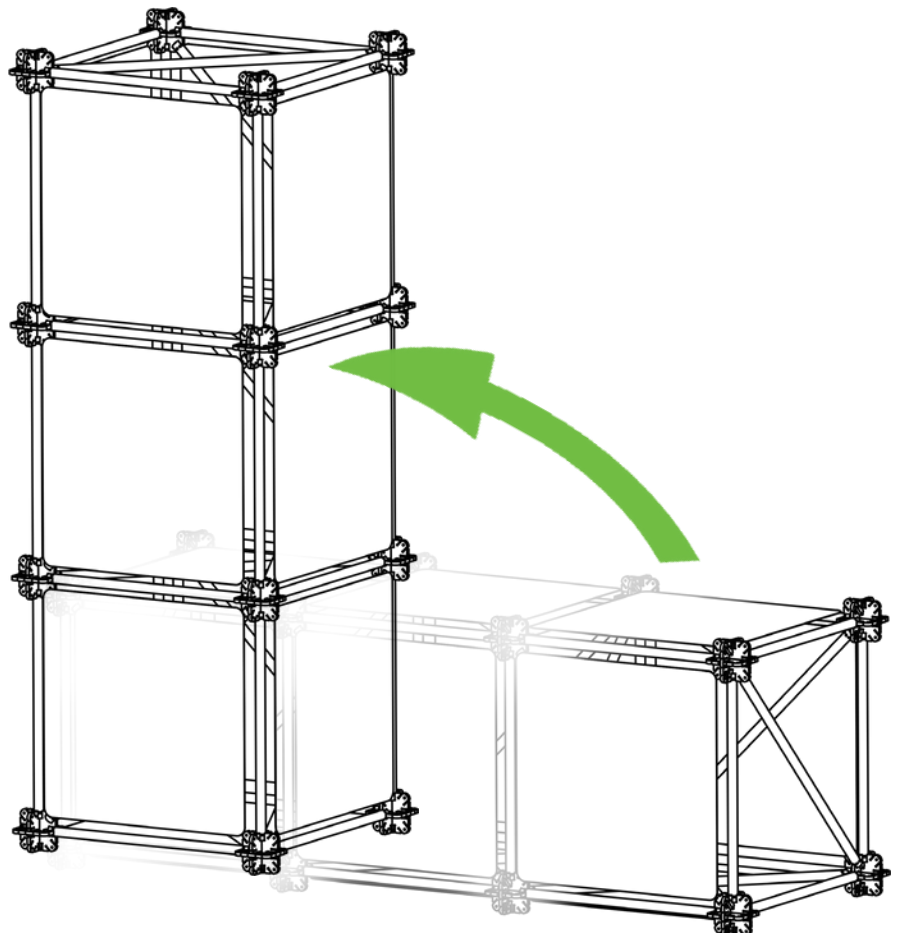

6. If you do not have another system, you can add a base so that the tower cannot tip over

